

# MT ROUSE News & Views



*Community Newsletter*

**History in the making -  
Mount Rouse & District  
Historical Society celebrates**



*Thank you Florence Collins for sponsoring this colour front page.*

## Historical Society 50th Anniversary

From the front page: Honorary life members of the Mt Rouse and District Historical Society, Brian O'Brien and Val Heffernan, cut a cake at the Penshurst Court House to celebrate the society's 50th anniversary. Mr O'Brien gave a brief report on how the society came into being and how its collections reflected the amazing history of Penshurst and District. The historical society was formally established in 1974 after an inaugural group called the Penshurst Historical Society formed the previous year. A detailed report of how it began was featured in the last newsletter.



Left: President Robert Collins with Treasurer Mary Johnson, and committee member David Jellie enjoying the gathering.



## Historical Society 50th Anniversary

The historical society now has an extensive collection of Penshurst and district history and opens on the first Saturday of the month to answer queries about the town's history. It's especially helpful for people compiling their family history.

Researcher, Brian O'Brien, was successful this year in gaining a \$4000 award from the Public Records Office to digitise the Penshurst Free Press from 1919 - 1928. The microfilm copies of the Free Press are in the State Library who will send them to Trove to be digitised and put online.

"Trove has been a huge benefit for family historians - they can see what a town was like and what their family was experiencing through the local newspaper," Mr O'Brien said. "Unless you have family letters and diaries, then the only way you are going to see what society your ancestors lived in is the local newspaper at a particular time in the town's history.

"You will be able to place your ancestors in Penshurst in the 1920s and see what kind of society they were living in," he said. The Penshurst Free Press is already on Trove from 1901-1918.

"History is important because it teaches us valuable lessons about life and what our ancestors experienced and what we can learn from it," Mr O'Brien said. "It also shows us what the issues were that our ancestors faced at a particular time in Penshurst's history." He hopes that in future years the remaining 52 years of the Penshurst Free Press (1928-1980) will gain funding so it can be digitised and published on Trove. "It costs about \$4000-\$5000 per decade to digitise at today's prices, so we need at least another \$25,000 to finish the Free Press. A wealthy benefactor would come in handy!"

The demise of country newspapers is also a worry about preserving future history - 200 country newspapers have closed in the past decade with the Hamilton Spectator being the latest after announcing its final edition will be December 21.

"The demise of newspapers is a real worry to historians for many reasons, but the fact that it's such a valuable source of history is something that really concerns me. Last week's news is history - where are future events in the community going to be recorded so that someone in 50 years time can read what happened in 2024? Is what happens in society that is currently recorded in newspapers going to be recorded online and kept permanently - love to think so but strongly doubt it," Mr O'Brien added.





The Combined Churches  
 Christmas Carols will be held  
 on Sunday 8th of December  
 2024 Commencing at 7.30pm  
 in the Penshurst Memorial

Hall

All Welcome



## ELDERS HAMILTON

*Proud to be a supporter of local communities*

**BRANCH MANAGER & RURAL**

**REAL ESTATE**

Lachy Patterson 0407 704 684

**WOOL**

Andrew Howells 0418 846 291  
 Kate Methven 0488 415 883  
 David Whyte 0407 347 203

**State Wool Manager**

Lachie Brown 0409 645 915

**LIVESTOCK**

Aaron Maiseed 0407 782 286  
 Jordy Anthony 0407 649 925  
 Dillon Dawson 0438 054 593

**STUD STOCK**

Ross Milne 0408 057 558

**MERINO STUD STOCK & WOOL**

Kevin Beaton 0455 119 711

**FARM SUPPLIES**

Ryan Gerring 0439 699 110  
 Damon Hiscock 0439 671 046  
 Rob Browne 0427 315 793  
 Rod Evans 0498 750 125  
 James Whyte 0458 322 094

**AGRONOMY**

Mark Rouse 0473 444 288  
 Gabby Redpath 0438 903 123

**SALES SUPPORT**

Ann Hiscock 5551 5700  
 Wendy Kerr 5551 5700  
 Annaleace Dohle 5551 5700  
 Maggie Craig 0427 976 179

100 Portland Road,  
 Hamilton P. 03 5551 5700  
 E. hamilton@elders.com.au  
 elders.com.au



### Council elect Heslin for mayor

By Felicity Handreck, Spectator Photo: Glenn Guy Reprinted with permission

ON Wednesday, November 20 at 5.30pm a statutory meeting which lasted less than 20 minutes was held to elect the new Southern Grampians Shire Council (SGSC). Councillor Helen Henry moved the recommendation that the mayor should be appointed for a one-year term which Cr Jayne Manning seconded. The motion was passed unanimously.

SGSC chief executive, Tony Doyle, called for nominations for the position of mayor. To be elected, a mayor must achieve an absolute majority of council, which is four votes. Cr Adam Campbell nominated Cr Dennis Heslin for mayor and Cr Heslin accepted. No further nominations for the position of mayor were put forward and with further ado, Cr was declared the SGSC mayor for 2024/25.

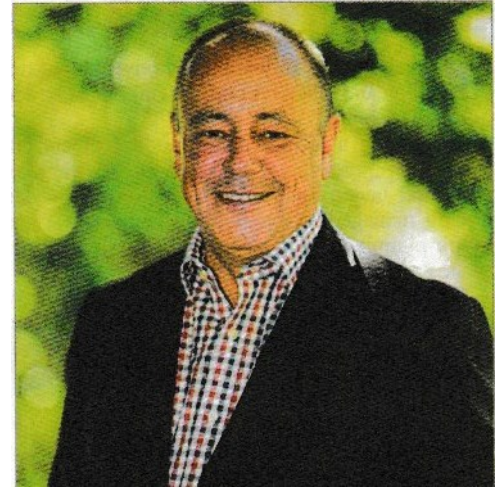

A previous property investment business operator, Cr Heslin came seventh place out of eleven nominations having gained 716 first preference votes in the recent SGSC election. Cr Heslin said, “It certainly goes without say that this is a massive honour, a privilege and a seat I never thought I’d be sitting in ... I’ll enjoy the challenges. “I’ll be doing what the role is, and that’s serving the community.”

Cr Heslin expressed his gratitude to his wife, Katrina, “(My) number one supporter.” “I’d first like to thank the community who felt I was worthy of being in this position. It started off with a small community, where we live in Penshurst, extended through to smaller communities, and of course, the big community here in Hamilton.”

Cr Heslin acknowledged that seven people had been elected to represent the Shire who had demonstrated to one another their openness and readiness for good conversations, “Without diluting the respect for each other and the respect for the role that we have.”

He wished to especially thank the executive team and said, “I’ve called on them for advice and words of wisdom along the way as well.”

He went on to thank Council staff. “Just seeing someone in the street who says, ‘I hope it all goes well for you’, irrespective of who they voted for. “They were just very encouraging and supportive of someone who wants to embrace their community for the community to embrace me as well.”

Cr Heslin addressed the councillors representing the Shire and said, “If I could suggest that we’re two things—(and that) is available and able. There’s a lot of experience there, and we’ll certainly be calling on those that have come before us and those who haven’t assumed these positions in the past as well. So, we’ll be looking to embrace all the skills within all of the individuals that exist in our community. So, I am extremely grateful and looking forward to it so much ... thank you,” the newly-elected mayor said.

The next point in the meeting would usually be the nomination and election of a deputy mayor, but the seven councillors (as per the Local Government Act 2020, with the provision to do so) decided not to nominate or elect a deputy mayor and to share the role of supporting the mayor amongst the other six.

### Penshurst Hair Design



**Opening Days**  
**Tuesday,**  
**Thursday**  
**Friday &**  
**every second**  
**Saturday**  
**10am - 2pm**  
**By Appointment**

For appointments please ring

**Mobile: 0417 511 177**

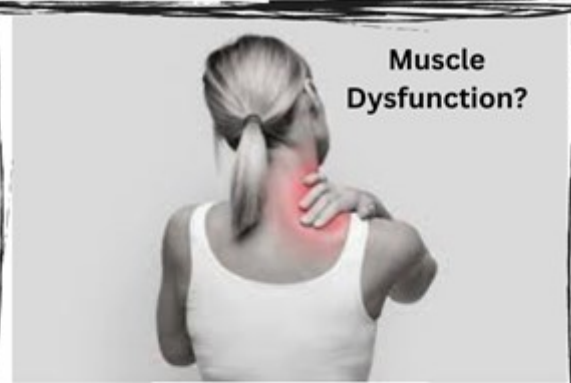

*Body Balance*  
**BODY BALANCE**  
an French

Scan QR Code for more details

Leanne Cottrill  
Remedial Massage Therapist  
mobile 0407835479  
13 French Street Penshurst 3289  
36A Thompson Street Hamilton 3300  
<https://body-balance-on-french.au3.cliniko.com/bookings>



### Penshurst Store



**Amanda & Cam Wilson**  
0439 941 942

**Pop into the store and try some of our delicious pies, pasties and sausage rolls. Freshly baked bread, cakes and slices.**

**Treat yourself to an Amanti coffee or Hot Chocolate and browse our everchanging giftware and local produce.**

**Phone orders and payments are welcome.**

**Monday - CLOSED**

**Tuesday to Friday - 7.30am - 2.00pm**

**Saturday – 8.00am - 2.00pm**

**Sunday - CLOSED**

**Café/Bakery**

**110 Bell Street, Penshurst**

**penshurststore@gmail.com**

### Caramut and District Garden Club

Sadly, this year we have seen below average rain fall and our gardens now require watering to keep them looking good. No amount of hand watering though seems to do as much good as a good soaking of rain.

Light watering, especially of shrubs and trees, only encourages the roots to stay on the top of the ground and they will blow over or die when it becomes hot and windy. If planting Australian trees, plant tube size plants in the wet spring surrounded by a tree guard – we used milk cartons. There is no need to water again as this encourages the roots to go down deep in search of moisture. We have done this on the farm, planting a thousand Wannon Falls seedlings a year and had great success.

A thick mulch prevents the soil from drying out in hot windy conditions. Give a good soaking at regular intervals to the garden beds. Vegetables need to be kept moist at all times to give consistent growth with good taste at harvest time.

Like us, plants droop in the hot weather even when well mulched and watered, but once the day cools down, spring up again. It is a good idea to cover plants when the temperatures soar to stop burning of leaves and extreme stress.

Mickey Bourke's Hotel in Koroit has been booked for our Christmas luncheon for 12.00pm on Tuesday the 10<sup>th</sup>. December. The cost is \$40 per head for a 2 course meal consisting of roast meat and vegetables followed by plum pudding and fruit salad. Please phone Marita (0439 669 839) if you are coming to the luncheon so numbers can be given to the Hotel for catering or for more information.

*A man full of words and not of deeds is like a garden full of weeds.*

Thank you to the Garden Club for their donation to the yearly newsletter 2024 - the Editor 

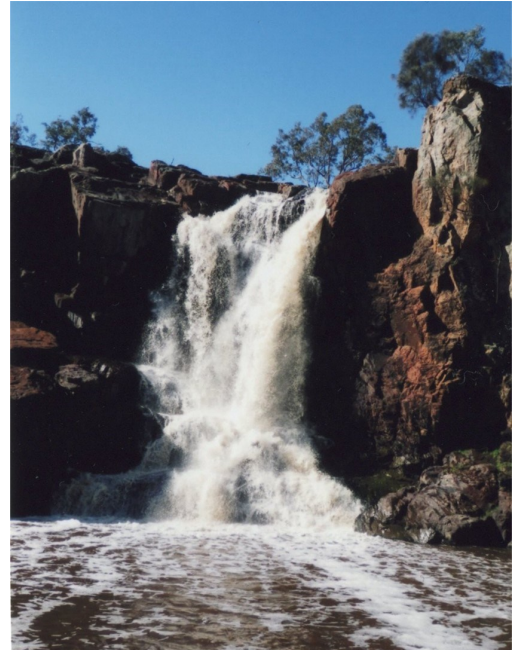

#### WANTED TO BUY

**3 x 2 wheel secondhand bikes**

30 - 50cm

Phone 0457 254 696



Penshurst Progress Association Inc

#### Annual General Meeting

& Community Meeting

**27th November 2024**

7.30pm

Penshurst Memorial Hall, Supper Room

*Everyone welcome*

The purpose of the meeting is to elect a new Committee of Management (Board).

ABN 35 622 662 815

president@penshurstprogress.org.au



### To plant is to hope - The parable of the tomato plants

There is a wizened gardener who grows tomato plants from seeds. Each year we are privileged to go and get some from him and you never know exactly what sort he has come up with. It's a real liquorice all sorts, a lucky dip sort of experience.

Each year we plant out these seedlings, we water, fertilise, wait and hope. I have to say that on the law of averages, the quality and abundance of fruit is always pretty good. I am sure this is due to the craftsmanship that has gone into nurturing these seedlings.

But... you just never know. There are no guarantees in this world, particularly when it comes to growing tomatoes in the garden. We simply plant, wait and hope.

It is like this with all things in the garden, fruit, veggies and flowers. There are no promises, no guarantees. You simply give it a jolly good try and you hope.

It's the same with relationships. You try, you work and then you hope. It seems nothing is happening and yet everything is happening. Sometimes it starts out robustly and then it falls over.

The ones that start out straggly often become the most productive and the ones that begin life sturdy and full of promise sometimes don't seem to reach the potential that was hinted at in the early stages of life.

When we plant things in the earth this is the risk we take. I think about this at every burial I conduct.

We tenderly, with great respect and thankfulness, plant the body in the ground. We then wait and hope. We have no way of knowing what the final outcome will be. We sort of have an idea but...

To plant is to hope.

### The privilege of grey hair

The inspiration for this reflection came from my attendance at the Remembrance Day service.

As I toddled along, I found myself thinking that my hair is quite a different colour than it was 40 years ago. I have photos to prove it!

When my hair first became more 'Silver Foxish' I used to bemoan this change in style. Not so much these days. For one thing the cost to change it would be a dubious call on my limited finances and for another I consider myself fortunate to have lived this long. Long enough for my hair to become 'distinguished'. I've been to far too many funerals now of gentlemen who did not have the opportunity to ponder this transition.

So the service began and a mighty fine turnout it was. There was music and medals in abundance. The last post always sends goosebumps up and down my spine to say nothing of a slightly 'clogging feeling' in my throat.

Beautiful wreaths of flowers were laid down and the classic poem Flanders Field was recited.

The students who laid the wreaths were smartly turned out in their uniforms and I could not help thinking that the people we were honouring were not that much older than these fresh-faced adolescents. A very sobering thought.

There was one excellent reflection about the unknown soldier, and it was rightly pointed out that while we can never know his name perhaps it is better that way for he symbolises everyone and is a reminder of our own mortality that we must all face one day.

If you are like me and you are sporting a silver fox hair do, remember these things. On Remembrance Day we pray for those who never had the opportunity to have the years of peace we have enjoyed.



**MEDIA RELEASE**

SOUTHERN GRAMPPIANS SHIRE COUNCIL



November 2024

**Celebrating International Day of People with Disability in the Southern Grampians**

Southern Grampians Shire Council is excited to announce a series of events to mark the International Day of People with Disability (IDPwD), celebrated worldwide on 3 December 2024. This day shines a spotlight on the achievements and contributions of people with disabilities while promoting a more inclusive community for everyone. Council invites the community to come together, celebrate, and recognise the diversity and strength within our region.

Starting at 9:00am on Sunday, 24 November, talented local artist Jesse Shannahan will begin work on a collaborative mural beside the Greater Hamilton Library. Residents are invited to join Jesse by painting or spraying a heart on the mural, symbolising support and love for our community members living with disabilities. The project is a unique way for all residents to get involved, share their artistic flair, and be part of a piece that truly represents the spirit of unity and inclusion.

On Tuesday, 10 December, Party with the Ponies returns to the Hamilton Racecourse, an event that has become a beloved fixture on the Southern Grampians calendar. Open to the broader community, this event will welcome disability and community groups from across the region, including Hamilton, Ararat, Terang, Portland, Warracknabeal, Warrnambool, and Millicent. Starting at 11:00am, the day promises something for everyone, with an animal nursery, face painting, crazy hair, giant ball games, parachute games, and roving entertainment. The highlight of the event is the much-loved Fashions on the Field. Other events will be popping up across the Shire at the Greater Hamilton Library and the Hamilton Gallery to mark the occasion. Keep your eyes on our social media for updates.

Southern Grampians Shire Council CEO Tony Doyle expressed his enthusiasm for the program, saying:

“Council is partnering with Hamilton Community House, the Hamilton Racing Club, and other groups to support and celebrate the people in our community who are living with disabilities.

“We encourage everyone to join in the celebration of IDPwD and to appreciate the incredible contributions of people with disabilities to our Shire,” he continued. “This day is a reminder of the importance of accessibility, equality, and inclusivity, and it invites all of us to play a part in creating a welcoming and supportive Shire for everyone.”

For more details on these events, please contact us at (03) 5573 0444 or visit our website to sign up for our [newsletter](#) and receive regular updates on projects and initiatives across the Shire.

**STANDING TOGETHER AGAINST GENDER BASED VIOLENCE**

As 25 November approaches, it brings with it the start of the 16 days of Activism where we fight for the elimination of violence against women. During this time, women's rights are recognised around the world with organisations and individuals raising awareness about gender equality and the devastating impacts of domestic violence.

This year, Southern Grampians Shire Council is joining Rotary Hamilton's Walk Against Domestic and Family Violence on Saturday 30 November 2024.

Rotary Hamilton's walk will start at 10:00am from the Hamilton Botanic Gardens (Thompson Street Gates) and will finish at the Hamilton PAC. Residents are encouraged to wear purple to support the end

Continued page 10

**MEDIA RELEASE**

SOUTHERN GRAMPPIANS SHIRE COUNCIL

**Standing Together Against Gender Based Violence**

(Continued)

to gender-based violence or orange in recognition of the 16 Days of Activism. Guest speakers will feature from Victoria Police, WDHS and Council and will be followed by a free sausage sizzle.

Southern Grampians Shire Council CEO Tony Doyle said the campaign is an important reminder that violence against women and children happens in our Shire and we can all take steps together to prevent it. "16 Days of Activism is an important time every year where we have the responsibility to have important conversations around the impact against gender-based violence has on our community. "We know statistically that gender-based violence is alarmingly high within the Southern Grampians so we have a lot of work to do as a community. "We know these conversations should be had year-round, but the 16 Days of Activism really puts a spotlight on what we are willing to accept as a community. It holds us responsible for having those difficult chats and challenges us all to look at the basic human right for equality. This is our time to say no.

"I encourage you all to get involved this year and make a visible stand. Join the walk against domestic violence, wear your purple and orange to show there is no excuse for gender-based violence within the Southern Grampians," concluded Mr Doyle.

In Australia, 23% of all women (1 in 4), have experienced domestic violence since the age of 15. Earlier this year Prime Minister Albanese declared Australia was facing a national crisis of violence against women, with one woman being killed every four days with the yearly figure at 58, up from 35 at the same time last year. Since his declaration, the figure has grown and alarmingly sits at 81 women murdered in 2024. While we recognise domestic violence against both Men and Women, locally Southern Grampians Shire was up 27.5% this financial year compared to last with over 75% of total incidents against Women.

The annual 16 Days of Activism Against Gender-Based Violence campaign begins on the International Day for the Elimination of Violence Against Women on 25 November and ends on International Human Rights Day, 10 December.

For more information on this initiative go to [www.respectvictoria.vic.gov.au](http://www.respectvictoria.vic.gov.au) or follow Council's social media pages.

**Small Acts Make a Big Impact:  
Southern Grampians Shire Council Joins New Statewide Recycling Initiative**

As part of a statewide push to improve recycling and sustainability practices, Southern Grampians Shire Council is partnering with Sustainability Victoria to launch a new campaign aimed at educating residents about enhanced recycling methods and services.

This initiative is a continuation of the successful Small Acts, Big Impact campaign, encouraging households to take small, meaningful actions that contribute to a more sustainable future. As part of the campaign, bin audits will be conducted at random throughout the Shire during November.

"This audit will allow us to see where we're doing well and where we can improve," said Southern Grampians Shire Council CEO Tony Doyle. "By identifying and reducing contamination in recycling and FOGO bins, we can divert more waste from landfill, conserve resources, and cut down on the environmental impacts of manufacturing with raw materials.

Continued page 11

**MEDIA RELEASE**

SOUTHERN GRAMPAINS SHIRE COUNCIL

**Small Acts Make a Big Impact**

(continued)

“All audits will be performed anonymously at random with no penalties or individual assessments to be issued, as the primary goal is to collect data that will shape future educational materials and programs. No data regarding the source of the waste material, or any identifiers in the waste will be recorded, only the volumetric and weight-based data by category will be documented.”

Managed in partnership with Waste Services, these audits will help Council assess the types and levels of contamination in household waste, recycling, and FOGO (Food Organics and Garden Organics) bins. By gaining a clearer understanding of current recycling practices, Council can gain an ongoing understanding of the volume of waste being managed, as well as bin content to assist with planning and budgeting for waste services management.

“This forms part of our commitment as a Council to deliver sustainable outcomes within the Southern Grampians and to take a lead in shaping the future of circular economy in our region. We know we have a significant role to play in delivering sustainable projects and improving the impact our current practises have. We have done a lot of work in this space over recent years and will continue to improve practises wherever possible,” concluded Mr Doyle.

With new recycling services and facilities set to launch across Victoria in the coming years, including statewide glass recycling, Council is committed to supporting residents as they adapt to these changes. By working together, Victorians will aim to divert 80% of waste from landfill by 2030.

For more information on this initiative, as well as practical tips on recycling and how small actions contribute to big changes, residents are encouraged to visit Sustainability Victoria’s website at [www.sustainability.vic.gov.au](http://www.sustainability.vic.gov.au).

Media inquiries: Jeff Greene, 0460 321 634, [jgreene@sthgrampians.vic.gov.au](mailto:jgreene@sthgrampians.vic.gov.au)

**A Spectacular Christmas Celebration is coming to the Southern Grampians**

The annual St Mary’s Christmas Parade will take over Hamilton on Friday 6 December 2024 with late night trading open for Christmas shopping. Starting at 6:00pm, the parade will march through the heart of the Hamilton CBD, along Gray Street and Brown Street before finishing in front of the Hamilton Performing Arts Centre.

The streets will be closed to traffic until 9pm, allowing pedestrians to move around freely and enjoy the festive atmosphere. “This year we are looking to not only support the St Mary’s Christmas Parade which we know is a season highlight but also get local businesses involved and help facilitate late night shopping to make the most of the parade crowd,” said Southern Grampians Shire Council CEO Tony Doyle. “Council will waive permit fees associated with street stalls to encourage our businesses for evening trading which can be enjoyed by the whole community. “Christmas is the perfect opportunity to get behind our stores and shop wherever possible, locally. It’s not only positive for our local businesses, but it’s good for the economy and good for our community. If there was a present under every tree that has been bought in our Shire, that would go a long way to supporting the fantastic businesses we have here in the Southern Grampians as we are really blessed with a great variety of options across the shire.”

Businesses are invited to take part in late-night trading by bringing stalls out onto the streets at the conclusion of the parade without permits or fees required.

Continued page 12

**MEDIA RELEASE**

SOUTHERN GRAMPAINS SHIRE COUNCIL



A Spectacular Christmas Celebration is coming to the Southern Grampians

(continued)

“To add to the festive atmosphere, extended shopping hours mean shoppers can take full advantage of the night to hunt for the perfect gift or simply soak up the Christmas cheer. “So bring the family and be part of a night that promises to be a lot of fun for the community. Let’s help make the St Mary’s Christmas Parade, the shopping, the atmosphere and the friendly faces light up Hamilton like never before,” concluded Mr Doyle.

Close friend of Council, Santa Clause, will also make an appearance as the guest of honour, roaming the streets to spread holiday joy and give his best wishes to children and families. Meanwhile, the lively sounds of local talent will fill the air as the annual Busking Competition adds festive tunes to the evening.

For more information, contact Southern Grampians Shire Council at 03 5573 0444 or visit Home Southern Grampians Shire Council ([sthgrampians.vic.gov.au](http://sthgrampians.vic.gov.au)).

The sleighbells are ringing, and the prawns are defrosting because Christmas is coming to the Southern Grampians.

*“A balanced diet is a cookie in each hand.” – Barbara Johnson*

*“Make the world a better place one cookie at a time.” – Unknown*

### **Council elect Heslin for Mayor (continued)**

Cr Heslin said, “We feel it’s a great way of just indicating to the community that we are embracing this role together. We may not always agree with each other, but we are one of the same.” Cr Heslin said that while the decision would allow councillors to be specially positioned where their skills lie, he also acknowledged the decision was uncustomary.

“If it doesn’t work, we can always change it, and we’ll certainly take advice (from) those close to us and those far from us,” he said.

Councillors were also appointed as representatives for the following committees: Audit and Risk - Crs Henry & Calvano; Planning - Crs Rainsford & Manning; Hamilton Regional Livestock Exchange Advisory - Crs Campbell & Rainsford; CEO Employment and Remuneration Advisory - Crs Heslin, Henry and Campbell; Hamilton Showgrounds Advisory - Crs Rainsford and Barber; Reconciliation Action Plan Working Group - Crs Heslin and Manning; MAV Delegate - Cr Rainsford, proxy Cr Calvano; South West Victoria Alliance - Crs Heslin and Manning; Rural Councils Victoria - Cr Heslin, proxy Cr Henry; Barwon South West Waste and Resource Recovery Group - Crs Henry and Manning; Green Triangle Action Group - Cr Campbell, proxy Cr Calvano; Rail Freight Alliance - Cr Rainsford, proxy Cr Barber; Ansett Museum Board - Cr Barber, proxy Cr Rainsford.

Council thanked retiring councillors for their hard work and commitment to the Southern Grampians community. “Council gives thanks to the outgoing mayor, David Robertson, and councillors for their commitment, dedication and for all their hard work across their Council term,” Cr Heslin said. Cr Henry acknowledged the privilege of learning from more experienced outgoing councillors and paid homage to the late, former Cr Greg McAdam who passed during 2023.

Council will meet for the first meeting of their four-year term on Wednesday, December 11 at 5.30pm.

## A PAGE TO SHARE RECIPES

**Carbonara Pasta Salad**

Prep Time 5 mins

Cook time 5 mins

Serves 4

From taste.com.au

## INGREDIENTS

250g dried Risoni pasta  
150g streaky bacon rashers  
2 baby cos lettuces  
4 boiled eggs  
20g (1/4 cup) shaved parmesan

Creamy Dressing  
125g (1/2 cup) sour cream  
65g (1/4 cup) mayonnaise  
2 tbsp fresh lemon juice  
2 tsp Dijon mustard  
1 bunch fresh chives

**Method**

Step 1 - Put the kettle on. Heat a non-stick frying pan over medium-high heat. Fill one third of a large saucepan with water and place over high heat. Cover and bring to the boil.

Step 2 - While the water heats up, coarsely chop the bacon. Separate the lettuce leaves, rinse and drain well.

Step 3 - Pour boiling water from the kettle into pan of hot water. Cover and return to the boil. Add pasta. Cook following packet directions for 2 minutes less than stated on the packet. Drain. Return to pan.

Step 4 - While the pasta is cooking, add the bacon to the hot frying pan and cook, tossing, for 2 - 3 minutes or until crisp.

Step 5 - As the pasta and bacon cook, place dressing ingredients in a jug, using scissors to snip in the chives. Whisk until well combined.

Step 6 - Arrange lettuce on a serving platter. Add 3 tablespoonfuls of dressing to pasta. Toss until combined. Scatter the pasta over the lettuce. Halve eggs and arrange on top. Drizzle over the remaining dressing. Scatter over the bacon and parmesan. Season and serve.



*"If you can't change the world with chocolate chip cookies,  
how can you change the world?" – Pat Murphy*

5576 5270

Friendly faces and helpful staff ...

**Penshurst Liquor & Grocery Store**

Open 7 days

**Opening Hours:**

**Monday - Friday**

7am - 7pm

**Saturday**

8am - 6pm

**Sunday**

8am - 5pm

80 Bell Street, Penshurst



Sandwiches & lunch packs available

Order your meat, fresh fruit & vegetables by phone for collection at your convenience

**Groceries - Bread - Frozen Foods**

**Beer - Wine - Spirits**

**Penshurst's News Agency**

“Chop your own wood and it will warm you twice.” Henry Ford

**CHRISTOPHER COOK CONSTRUCTIONS**

**Ph: 0417 100 243**

**Fax: 5576 5267**



**HIA Reg CB-U 6214**

**DB-U 5109**

**112 Bell Street  
Penshurst Vic 3289**



- Agronomy Services
- Farm Production & Planning Management
- Seed & Fertiliser Supply
- Crop & Pasture Protection Products
- Animal Health & Nutrition
- General Merchandise
- On Farm Deliveries

Western AG's core objective is to provide high quality production advice and to supply competitively priced inputs to assist clients to grow the business profitably.

**Western AG Hamilton - T: 03 5579 5900**

Tim Wilson (Branch Manager) 0429 168 020

Matt Barber (Senior Agronomist) 0488 298 170

Damien Goodman (Agronomist) 0427 159 462

Geordie Elliott (Nutrition & Production) 0438 874 587

Meg Todd (Animal Health ) 0437 772 861

**Western AG Willaura - T: 03 5354 1585**

Glen Gray - 0439 541 036

Mount Rouse Puzzler

Across:

1: Opposite to bottom.

5: To suggest an idea or theory.

8: To cause someone to do or want to do something even though it may be wrong, bad, or unwise.

12: A liquid, esp. brine or vinegar, in which food is preserved.

14: To shake slightly because you are afraid, nervous, excited, etc.

15: A wheel that spins quickly and is held in a frame that allows it to tilt in any direction.

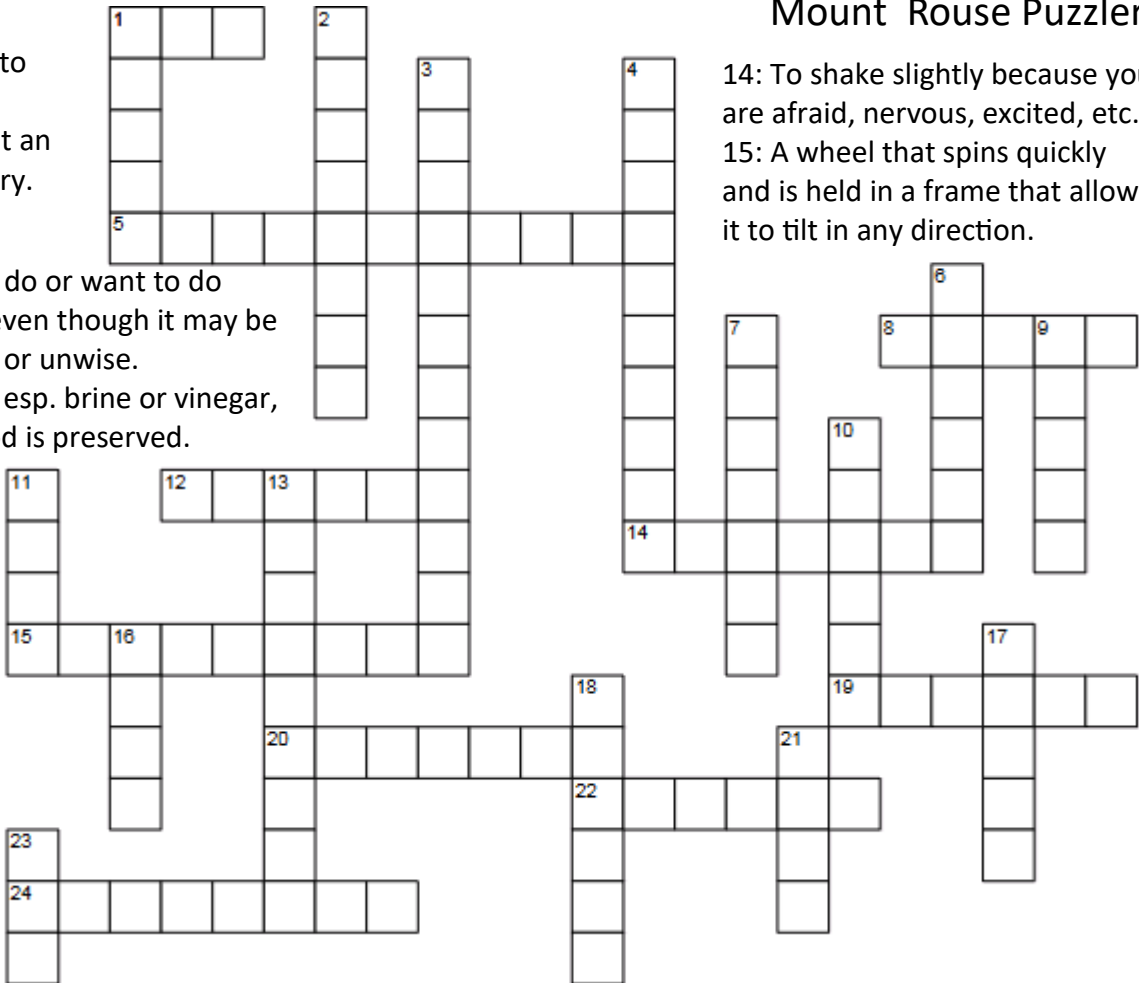

- 19: Unusual and interesting from far away.
- 20: An official document, card, etc., that gives you permission to do, use, or have something.
- 22: A beverage consisting of an infusion of ground coffee beans.
- 24: Not guilty of a crime or other wrong act.

Down:

- 1: The quality of being true.
- 2: The act or process of joining something to something else.
- 3: The ability to learn or understand things or to deal with new or difficult situations.
- 4: The act of judging or deciding the amount, value, quality, or importance of something.
- 6: To say that you will not do or accept something.

- 7: Something that is not known.
- 9: Something which shows that something else is true or correct.
- 10: Able to move from one place to another.
- 11: A piece of jewellery that is worn usually on a finger.
- 13: Become widely known and passed on.
- 16: To cause something to move somewhere by turning over and over or from side to side.
- 17: To cook food with vapour.
- 18: A period of 10 years.
- 21: Money that you pay in return for being able to use property and especially to live in an apartment, house, etc., that belongs to someone else.
- 23: Another name for a can.

Crossword answers from last newsletter: **Across:** 2 quippery, 3 snowfield, 4 blistering, 8 catacoustics, 13 gnathion, 14 isobar, 16 pediculous, 18 oometer, 22 nubulous, 23 bellows, 24 fairing, 25 relief. **Down:** 1 whimsical, 5 ramshacked, 6 batrachivorous, 7 areology, 9 cellophane, 10 plebeian, 11 maypole, 12 mussitate, 15 vestry, 19 joyous, 20 gyrate, 21 clowder.

### Penshurst Shed

Open

Saturday & Tuesday  
10am - 4pm

Penshurst Mens shed is recreating its Not-for-Profit status. We'd like to thank the Penshurst Progress Association for hosting us as we regrew after COVID. Now, with quite a few new members in our ranks, we are looking to a bright and busy future.

Talk to the crew for more information about the Shed and its activities.

We are open for everyone.

**Contact**

Tom Cooke 0488 557 345

### Penshurst Post Office

31 Martin Street

Post Services

Gifts & Cards

Stationery & Office Supplies

Collectables & Books

Craft Supplies

Tech Accessories

Bank @ Post



Post Office Boxes Available



**DAN TEHAN MP**  
FEDERAL MEMBER FOR WANNON

*Working  
for  
Wannon*



Local Call 1300 131 692

190 Gray Street Hamilton 3300

www.dantehan.com.au

dan.tehan.mp@aph.gov.au

DanTehan

DanTehanWannon



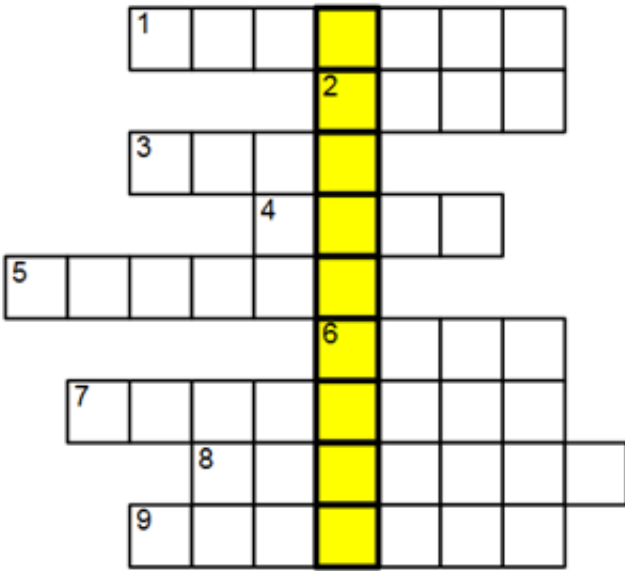

Fill the answers of the clues in the puzzle. If you have done this, you will find the hidden word in the bold rectangles.

Clues:

1. In a fast or quick manner.
2. In this place.
3. In an upward and forward direction across something.
4. Having (a particular characteristic, possession, etc.).
5. To take with oneself to a place.
6. (at) that time (in the past or in the future).
7. The 11th month of the year.
8. Describes rain, sunshine, wind etc.
9. Not normal or usual.

Hidden Word is .....

For the kids

Below - Addition Maze. Start at your feet and work your way to the treasure. Have fun!

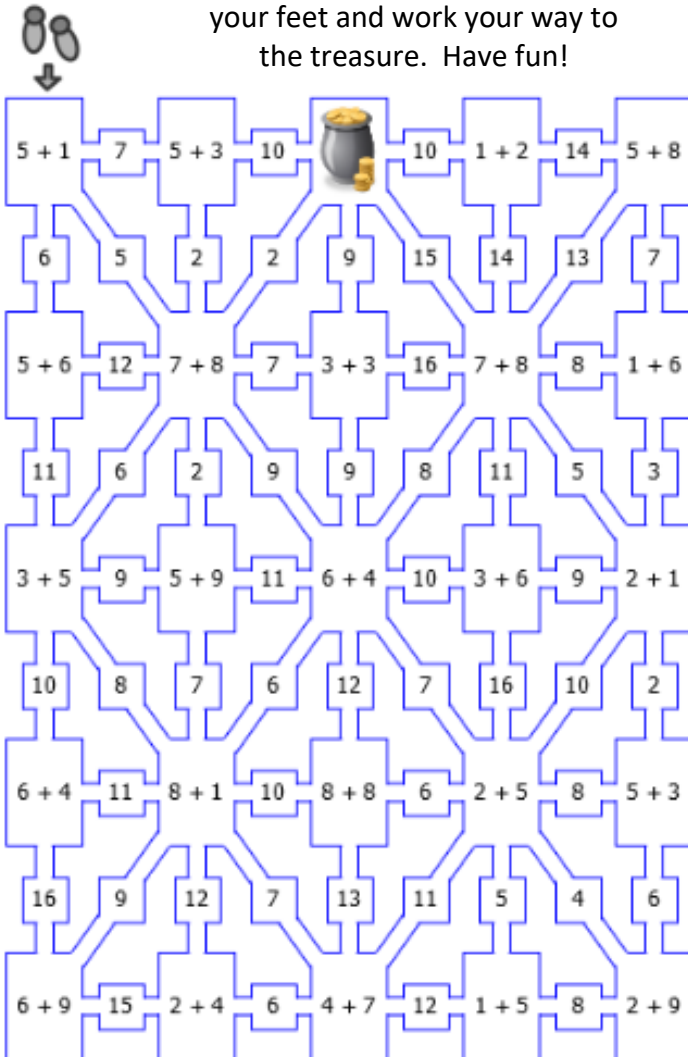

n	o	w	w	h	t	y	d	r
d	n	a	c	o	h	o	u	a
e	a	t	h	l	i	s	v	w
r	e	h	i	e	w	u	s	n
f	r	e	n	g	o	h	t	w
u	l	a	k	e	n	a	r	o
o	o	m	u	e	g	o	g	d
n	e	a	g	s	e	o	m	d
e	w	r	d	s	o	r	f	o
p	w	a	w	h	w	s	l	l
u	v	e	r	e	d	i	i	t

**Above - Zig Zag words:**

Find all these words in the puzzle.

All the letters must be connected by tiles on top, below, left or right from it, but not diagonally.

How strange this whole thing is. Where do we go from here? Upward, downward - I guess you can make it. Wonderful.



# PENSHURST CHRISTMAS LIGHTS DISPLAY & COMPETITION

This year there's just one category  
- "FAVOURITE LIGHTS"  
so anyone can win!

## THE LIGHTS

need to be up by 7pm Dec 8th.

## A MAP

showing all the entries will be available  
in this newsletter on Wednesday Dec 11th., the  
Penshurst Post Office and on  
Penshurst Victoria's Facebook page

## VOTING OPENS

on Dec 11 -  
a voting form & instructions will be printed  
in next fortnight's newsletter  
with voting open until 4pm Dec 24th

## ENTRIES ARE OPEN!

see the next page for info...

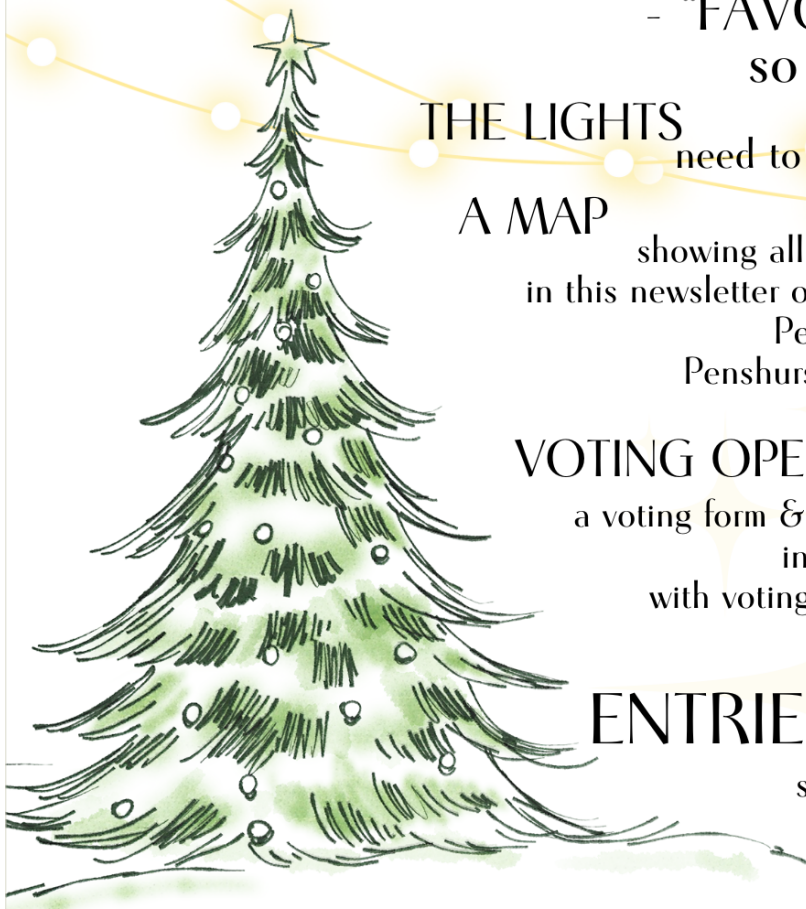

LET'S MAKE THE TOWN SHINE BRIGHT

# PENSHURST CHRISTMAS LIGHTS DISPLAY & COMPETITION

## ENTRIES ARE OPEN!

We encourage all residents of the Peshurst township to enter so we can include your address on the map of lights. This will ensure everyone can find and enjoy them.

THIS YEAR THERE'S JUST ONE CATEGORY -  
"FAVOURITE LIGHTS" SO ANYONE CAN WIN!



Thanks to Peshurst Lions Club and  
Peshurst Progress Association

the prizes are:  
1st \$150  
2nd \$100  
3rd \$50

### TO ENTER

Complete this entry form and drop it in the box at the Peshurst Post Office by 4pm Friday December 6th.

Lights must be up by 7pm Sunday December 8th.

Voting closes 4pm Tuesday, Dec 24, winners announced 4:45pm

### YES! I WISH TO ENTER THE LIGHTS COMPETITION

Your name: \_\_\_\_\_

Your address: \_\_\_\_\_

Your signature: \_\_\_\_\_ Date: \_\_\_\_\_

Note: Please ensure your street number is CLEARLY VISIBLE AT NIGHT so you do not miss out on votes. ALSO, by entering, you are consenting to your address (only) being published on the map in this newsletter and shared on social media. Entries are strictly limited to the Peshurst 3289 township.

### LET'S MAKE THE TOWN SHINE BRIGHT

## Community Meetings

### Boram Boram Cemetery Trust

- Contact Jeff Jellie 0407 781 407 or Sue 0418 141 301

### Caramut & District Garden Club

- 2nd Tuesday monthly at 10 am. See Garden Notes for venue.

### Penshurst Hospital

- Combined Churches service 3rd Tuesday every month in W.J. Lewis wing at 11 am.
- Residents, Relatives & Carers group, Tuesday bi-monthly, 1:30 pm.

### Penshurst Social Support Group

- WDHS meets every Thursday; for Exercise, Activities, Outings and General chit chat. Join us for lots of fun & laughter, Sheppard Centre, - Penshurst Hospital. Please contact Fiona Social Support Group Coordinator on 03-5551 8381 Or @ WDHS on 55518683

### Mount Rouse & District Historical Society

- Meetings - 4th Sunday in January, March, May, July, September and November, 2pm at the Court House. New members are most welcome. Contact the Secretary 0418 141 301. The Court House open for Visitors 1st Saturday each month 9.30 am to 12.30 pm.

### Friends Yatmerone Reserve

- Meeting 2nd Tuesday every second month, commencing February at Volcanoes Discovery Centre 7.30 pm. New members welcome.

### Lions Club of Penshurst & District

- 1st Friday dinner meeting. 3rd Tuesday business meeting, each month at 8 pm at Penshurst Memorial Hall, 21 Martin Street. penshurst.vic@lions.org.au

Penshurst Book Club - meets 3rd Tuesday each month at 2pm. Contact Ruth Pihl on 0490418313



**AmbulanceVictoria**

The Penshurst Branch is staffed by local Ambulance Community Officers (ACOs).

Ambulance Victoria is looking for people to join the Penshurst team. If you are interested in becoming an ACO or would like further information, please follow the link below.

<https://www.ambulance.vic.gov.au/careers/become-a-first-responder/>

### Penshurst Bowls Club

- Pennant Season (October - February) meets 1st Thursday at 7.30pm Alaister 0427 555 973
- Off Season 1st Tuesday at 7.30pm.

### Penshurst Pony Club Rally

- 1st Sunday each month. Phone Jenni 0409 962 969

### Penshurst Senior Citizens

- Meets at the club rooms in Bell Street.
- Bingo.

## Penshurst Church Services

### Bethlehem Lutheran Church Tabor

Service every Sunday 10.00am

### Penshurst Anglican Church

5pm Mass 4th Sunday each month

For further details contact  
Fr. David Oulton 0435867040

### St Andrew's Uniting Church Penshurst

2nd & 4th Sunday

11am Service

### St Joseph's Catholic Church Penshurst

1st Sunday No Service

2nd Sunday Mass 5pm

3rd Sunday Lay Service 8.30am

4th Sunday Mass 5pm

5th Sunday No Service

Penshurst Progress Association Inc

21 Martin Street, Penshurst VIC 3289

ABN 35 622 662 815

president@penshurstprogress.org.au



Australia Day

# Australia Day Nomination Form

## Penshurst Citizen of the Year 2024

Name of Nominee: .....

Reason why you nominated him or her (or group):

.....  
.....  
.....  
.....

Your name: .....

All Nominee names are kept confidential

Contact no: .....

Thank you for submitting your nomination

Date: .....

Please return by email or drop in the Red box at the Post Office by  
31<sup>st</sup> December 2024. Thank you.

Mt Rouse News & Views  
Community Newsletter

Published by  
**Mt Rouse Community Newsletter Inc**  
ABN 95 801 619 635

**“Mt Rouse News & Views Community  
Newsletter”**

is the registered business name of the  
Penshurst Community Newsletter

Registered Address: 103 Cobb Street,  
Penshurst 3289

**DEADLINE FOR CURRENT SUBMISSIONS -  
Saturday 7th December 2024**

The newsletter will be published on  
Wednesday fortnightly and we would  
appreciate submissions at the earliest  
possible time within the fortnight but  
no later than the Saturday immediately  
prior to the Wednesday of publishing.

**Editor : Ama Cooke**

All correspondence to:  
mtrousenewsletter@gmail.com

Also available in colour online at  
[www.penshurstvictoria.com.au/  
Penshurst%20Newsletter.html](http://www.penshurstvictoria.com.au/Penshurst%20Newsletter.html)

**Newsletter Advertising Rates  
(Per Issue, includes GST)**

**Full page B&W** \$22

**Full page colour** \$27

**1/2 page** \$13.20

**1/3 page** \$8.80

**1/4 page** \$6.60

**Business Card** \$4.40

Our newsletter is free thanks to the  
continuing support of our advertisers.  
Thank you.



***Mt Rouse News & Views  
Community Newsletter***

**Sponsor our colour front page**

Would you like to sponsor the colour  
front page of our community  
newsletter?

Other pages can be sponsored too.  
Cost is \$27 per coloured page per issue.

For more information  
contact the Editor  
Ama Cooke 0402 870 738



**Mobile Library**

Will be visiting Penshurst  
every Thursday fortnight  
3.00 - 4.00pm

**Outside the Hall in Martin St**

Dates for  
December 5th & 19th

**Phone: 5573 0470**

**[www.sthgrampians.vic.gov.au/library](http://www.sthgrampians.vic.gov.au/library)**

**LIKE US ON FACEBOOK  
GREATER HAMILTON LIBRARY**